

## 1. Introduction

The CampurSoft ROM Board has been designed to be used with the Amstrad CPC series of computers. It can be used directly with the CPC464, CPC664 and CPC6128. To use with the CPC464+ and CPC6128+, an Expansion Port Adaptor or WIDGET (available from WAVE on 0129 870000 for £9.99) is required because of the different type of connectors used.

It can accommodate up to 8 ROMs. These can be located in slots 0-7 or 8-15. The choice of slot number is set by fitting/removing of links (see later).

Additional hardware can be added by connecting to the Expansion Port Through Connector which replicates the CPCs Expansion Port. Pin 1 on the through connector is on top (where the cable is joined) and is indicated by a BLACK line to the side of the contacts.

## 2. Installing ROMs

To access the ROM slots, follow the instructions set out below :-

- i) Remove the 4 retaining screws from the corners of the box.
  - ii) Lift of the lid (using the slot at the opposite end to the connector to help) and the boards inside will come with the lid.
  - iii) Two boards are used, namely a CONTROL Board which is attached to the lid via 4 plastic stand-offs, and a ROM Board which is attached below the CONTROL board via a further 4 plastic stand-offs. The two boards are connected together by a short length of 40-way ribbon cable.
  - iv) Detach the ROM Board from the CONTROL Board by unclipping the 4 plastic stand-offs. This is achieved by simply squeezing the pointed end of the stand-off in so that it will go back through the hole it is protruding from.
  - v) The ROM Board will now hang free from the CONTROL board and lid.
  - vi) 8 ROM slots numbered ROM 0 to ROM 7 are now visible as well as a DIP SWITCH used to select the appropriate ROM. ROM 0 to ROM 7 will be replaced by ROM 8 to ROM 15 as appropriate. The DIP SWITCH is numbered 1 to 8 and should be read as 0 to 7 (or 8 to 15).
  - vii) Carefully fit your ROM in the chosen socket, ensuring that the groove in the ROM is matched up with the groove in the socket and move the appropriate switch to the RIGHT (ON). Make sure that the delicate legs are not bent in the process of fitting the ROM. If they are, gently re-straighten them.
- NOTE: ROMs are sensitive to static discharge, which can for example, be built up by walking on carpets. This static discharge can damage your ROMs. To be safe when handling them it is advised to briefly hold a metal cold water tap or some other point connected to earth before touching them.
- viii) Re-attach the ROM Board to the CONTROL Board and replace the lid on the box.
  - ix) Attach the 50-way connector (2 rows of 25 holes) on the cable supplied to the connector on the front of the box, ensuring that the word TOP is at the top.

x) Attach the Expansion Port Connector to the CPC so that words on the connector are visible at the top.

xi) Switch the computer on and the ROMs installed should give the appropriate sign-on message.

### 3. Equipping Options (Links)

This section describes the equipping options available to configure the CampurSoft ROM Board for ROMs 0-7 or 8-15, as well as the special considerations needed for ROMs 0 and 7.

The links are located on the CONTROL Board and their positions are shown on the Silk Screen/Component Locator diagram included with the box. A link is made by fitting one of the small jumpers provided over the pins on the board. These are set to configure the ROMs for 0-7 by default when the box is received.

The CONTROL Board is accessed by first removing the ROM Board as described in Section 2 above. The CONTROL Board can then be unclipped from the 4 plastic stand-offs attaching it to the lid.

(a) Links LK3-LK5:- These links are in the bottom left hand corner of the CONTROL Board and are used to select either ROM numbers 0-7 or 8-15. Link LK3 should be fitted as shown on the diagram when the board is first removed. This allows you to select ROMs from slot 0 to slot 7.

To select ROMs from 8 to 15, remove LK3 and fit links LK4 and LK5 in it's place, noting their position from the diagram.

The easiest way to distinguish between the two set-ups is by observing that LK3 covers the two vertical posts on the left of the 4 posts available whereas LK4 and LK5 cover all 4 posts and are mounted horizontally. The diagram makes this clear.

(b) Link LK1 (ROM 0):- This link is located to the top right of IC3.

When link LK3 is fitted (as described above) your choice of ROMs is 0-7. To incorporate ROM 0 special consideration is needed.

ROM 0 has to be of the 'BACKGROUND' type, to which the operating system automatically goes. If no external ROM 0 is used, link LK1 must not be fitted. This is because the signal ROMDIS would otherwise be active high on power-up and would disable the BASIC ROM. If no ROM is fitted the CPC would continuously reset.

I believe that the HACKIT ROM from Siren Software is the only other example of ROM 0 available for the CPC. This would be the only other occasion on which LK1 should be fitted when LK3 is fitted.

If links LK4 and LK5 are fitted to select ROMs 8 to 15, LK1 should be fitted.

(c) Link LK2 (ROM 7):- This link is located to the bottom right of IC3.

To incorporate ROM 7 when link LK3 is fitted, special consideration is also needed.

ROM 7 is automatically designated by the CPC as the DISK ROM. This is a 'BACKGROUND' ROM which sets up RSX commands to be able to use it. If no alternative DISK ROM is used, link LK2 must not be fitted. Otherwise the DISK ROM would not be initialised because none is present. A suitable replacement for ROM 7 is PARADOS which can replace the internal DISK ROM completely, for which LK2 can be fitted.

Alternatively, ROMDOS uses the original DISK ROM and LK2 should therefore not be fitted.

**NOTE:** PARADOS will not always work in ROM slot 7. This depends upon the version of the CPC6128 you have. On earlier versions of this machine, the internal DISK ROM cannot be disabled. For the best compatibility, PARADOS should be installed inside the machine if possible. With the CPC464 this is not a problem because the DISK ROM is located in the DDI interface. This is can be removed to fit PARADOS in it's place.

When links LK4 and LK5 are fitted to select ROMs 8 to 15, link LK2 should be fitted.

#### 4. Upgrades

CampurSoft will upgrade eight socket Romboxes to fifteen sockets for £32.00 + postage of £2.00. For further details contact us on 0141 554 4735.

#### 5. Guarantee

This product is guaranteed for a period of one year from date of purchase. If you have any problems please return the ROMBOX to CampurSoft for examination/repair.

#### 6. Design

This Rombox was designed and produced by Paul Collins. Documentation and circuit diagrams also by Paul Collins.

First released by CampurSoft in February 1995.

## CAMPURSOFT ROM-BOARD

SILK SCREEN / COMPONENT LOCATOR  
VIEWED FROM COMPONENT SIDE

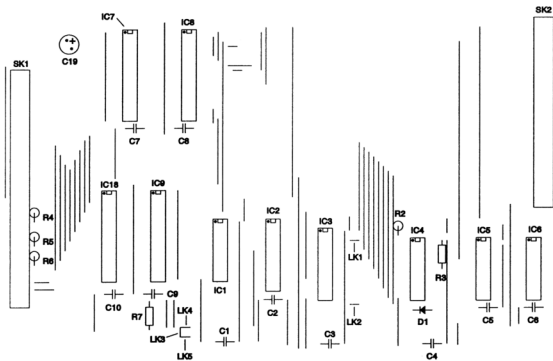

## CONTROL BOARD

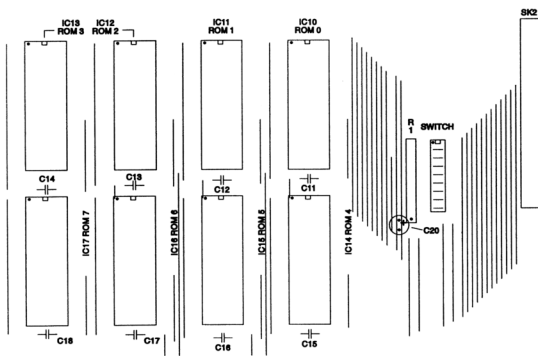

## ROM BOARD

## CABLE MODIFICATIONS FOR SECOND ROM-BOARD (MAPLIN CONNECTOR CODE : FA40T)

---



CABLE GUIDE - SIDE VIEW



RIBBON CABLE

RED WIRE



CONNECTOR BODY - SIDE VIEW



CONNECTOR BODY - TOP VIEW



FINISHED ASSEMBLY - SIDE VIEW

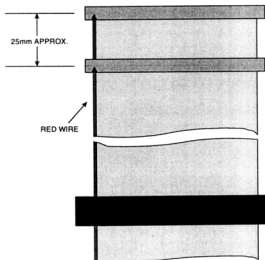

ORIGINAL CONNECTOR - TOP VIEW

ADDITIONAL CONNECTOR - TOP VIEW

EXPANSION BUS CONNECTOR - TOP VIEW

# CAMPURSOFT ROM-BOARD

## CIRCUIT DIAGRAM SHEET 1 OF 2

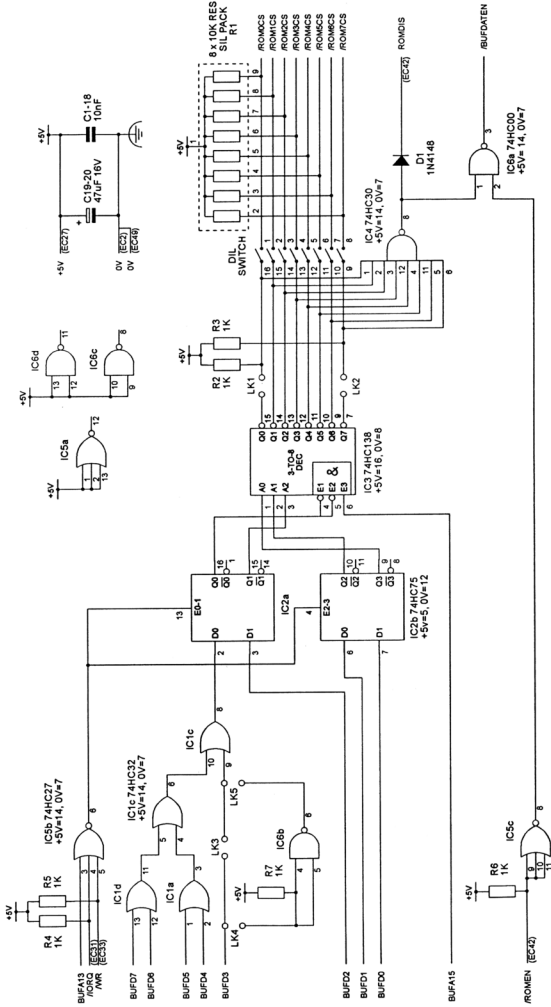

# CAMPUSOFT ROM-BOARD

## CIRCUIT DIAGRAM SHEET 2 OF 2

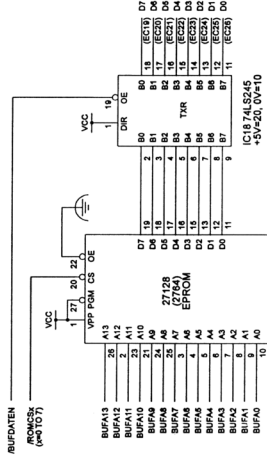
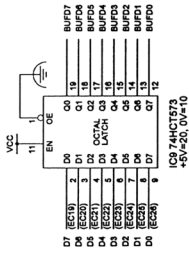
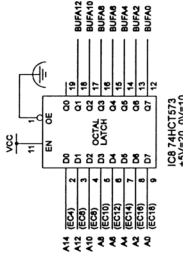
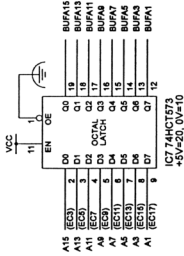

NOTE: ALL ROMS DO CONNECTED TOGETHER AND THEN TO IC18 INPUT. THE SAME FOLLOWS FOR D1 TO D7.